

**METRO 50 TRACK LIGHTS**

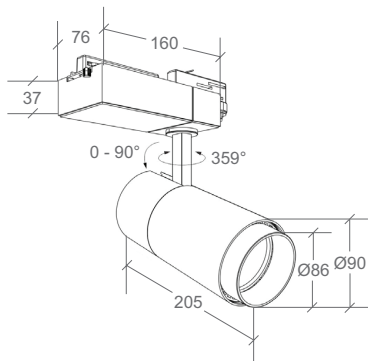

VOLTS	220–240V AC 50/60Hz input
OPERATING TEMP.	-20°C ~ +40°C
SOURCE LIFE	50,000 hours
LED BRAND	Citizen
WARRANTY	5 years
HOUSING	Die-cast aluminium
WEIGHT	1.63kg
INGRESS PROTECTION	Indoor use only
CONNECTION METHOD	3-phase track connector
CONTROL	Non-dimmable



Please read these instructions carefully before commencing installation and retain them for future reference. It is recommended that the luminaire is installed by a qualified electrician. All electrical installations must be carried out according to current electrical regulations.

These products must not be modified. If any modification is made, it may invalidate the warranty and render the product unsafe.

**INSTALLATION**

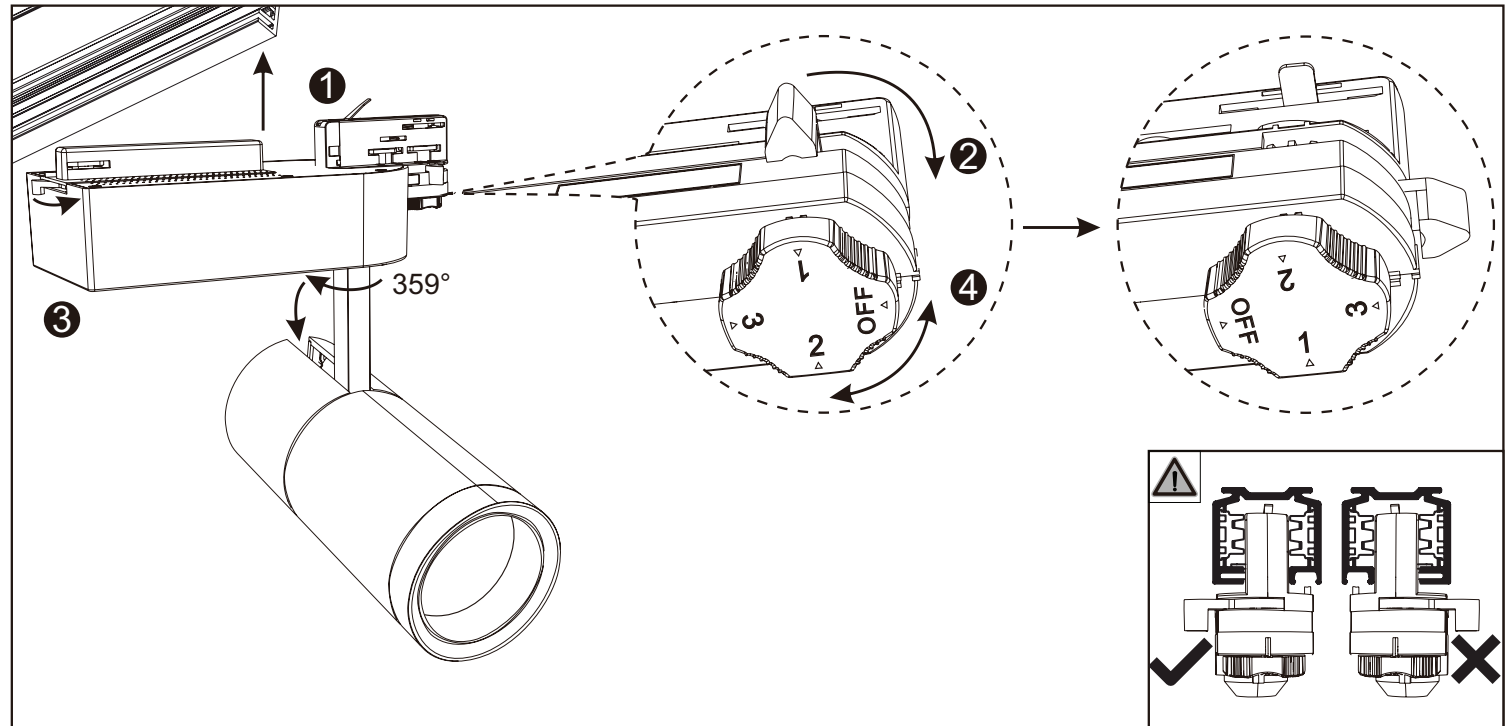

**SAFETY NOTES**

- Switch off the electricity at the mains before commencing installation.
- If a fuse box is used, remove the appropriate circuit fuse to avoid accidental switching on of the mains supply.
- Connect to a 220-240V AC supply in accordance with NZ regulation.
- Make sure all connections are tight with no loose strands.
- Ensure fire regulations are not breached when fitting downlight.

**WARNING**

- Indoor use only.
- Please ensure the packaging is disposed of safely.
- If any cable is defective, do not use.
- Only a registered electrician should install this product.
- Do not look directly at the lamp.

